

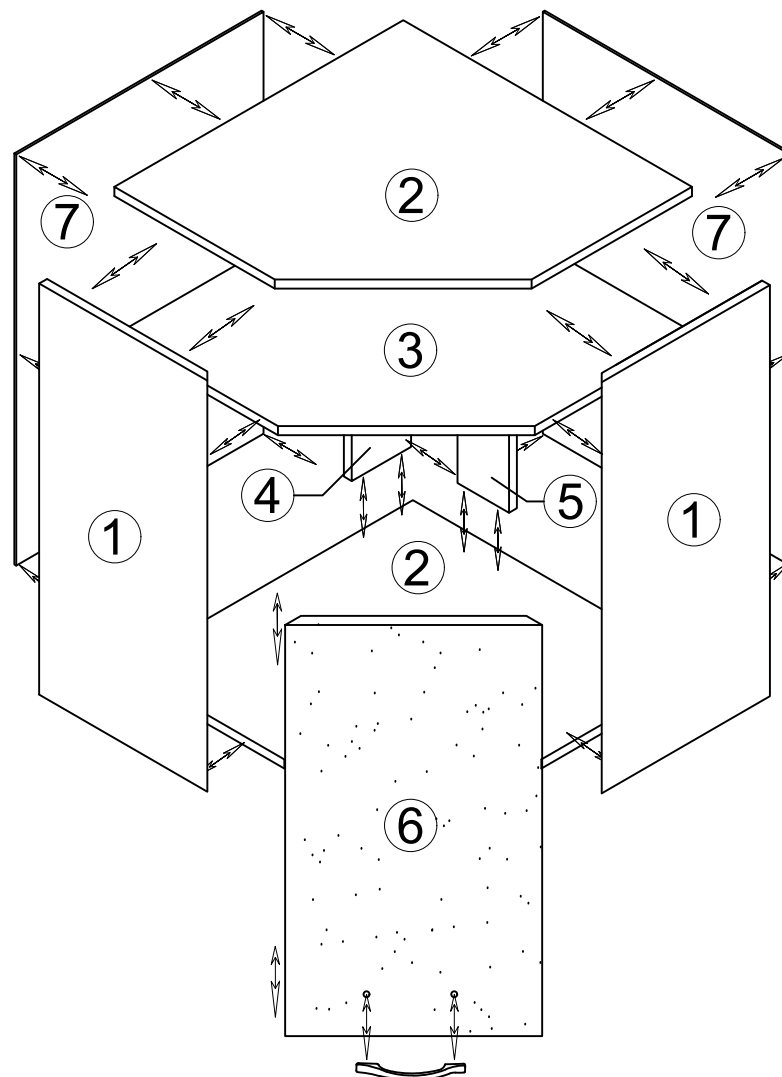







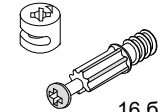

PG 10-600

Спцификация на детайлите

№	Наименование	Дължина	Ширина	Бр.
1	Страница	720	296	2
2	Дъно и таван	584	584	2
3	Рафт	584	584	1
4	Гръб	688	120	1
5	Гръб	688	104	1
6	Врата	716	419	1
7	Фазер	715	500	2

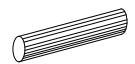

<p>Рафтносачи</p>  <p>6 бр.</p>	<p>Сглобка minifix</p>  <p>16 бр.</p>		
<p>Панта 135° с планка</p>  <p>2 бр.</p>	<p>Дръжка</p>  <p>1 бр.</p>	<p>Винт 3.5x16</p>  <p>24 бр.</p>	<p>Болт М4 х 25</p>  <p>2 бр.</p>
<p>Винт 5x60</p>  <p>4 бр.</p>	<p>Гвоздей</p>  <p>0.03 кг.</p>	<p>Дибла</p>  <p>20 бр.</p>	<p>Окачвач с пластмасова капачка</p>  <p>4 бр.</p>